

Oil Well Pump Three-Phase Motors

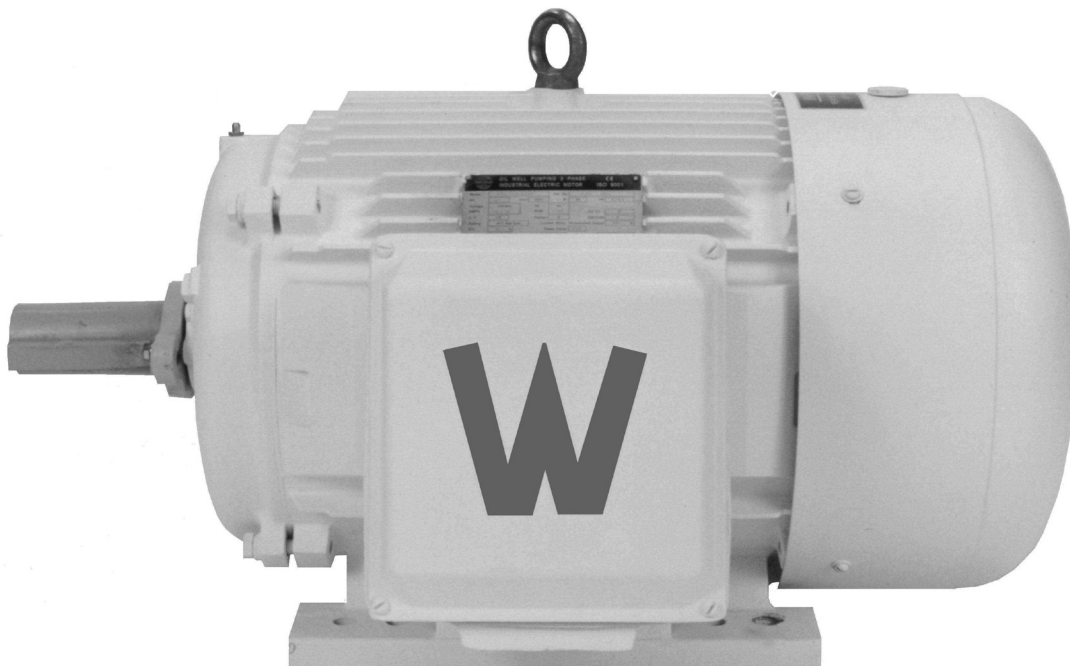

**All Motors In Stock
At Factory-Direct Prices!**



- ▶ **3 HP - 100 HP**
- ▶ **1200 RPM**
- ▶ **208-230/460 Volt**
- ▶ **TEFC Enclosure**
- ▶ **Design D - High Slip**



WorldWide Electric Corporation

Oil Well Pump Three-Phase Motors



- ▶ 3 HP - 100 HP
- ▶ 1200 RPM
- ▶ 208-230/460 Volt
- ▶ TEFC Enclosure
- ▶ Design D - High Slip

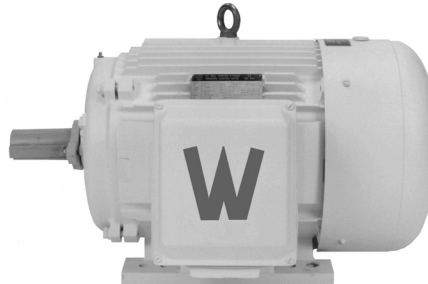

HP	RPM	Voltage	Frame Size	Enclosure	Model Number	List * Price
3	1200	208-230/460	213T	TEFC	WO3-12-213T	\$801.21
5	1200	208-230/460	215T	TEFC	WO5-12-215T	\$948.79
7.5	1200	208-230/460	254T	TEFC	WO7.5-12-254T	\$1,187.80
10	1200	208-230/460	256T	TEFC	WO10-12-256T	\$1,616.49
15	1200	208-230/460	284T	TEFC	WO15-12-284T	\$2,031.16
20	1200	208-230/460	286T	TEFC	WO20-12-286T	\$2,494.13
25	1200	208-230/460	324T	TEFC	WO25-12-324T	\$2,916.48
30	1200	208-230/460	326T	TEFC	WO30-12-326T	\$3,456.52
40	1200	208-230/460	365T	TEFC	WO40-12-365T	\$4,673.12
50	1200	208-230/460	404T	TEFC	WO50-12-404T	\$5,243.01
60	1200	208-230/460	405T	TEFC	WO60-12-405T	\$5,571.51
75	1200	208-230/460	444T	TEFC	WO75-12-444T	\$8,058.96
100	1200	208-230/460	445T	TEFC	WO100-12-445T	\$9,111.59

* Prices In This Brochure Are List - Please Call For Your Multiplier



Oil Well Pump Three-Phase Motors



High Efficiency
cCSA_{US} Certified
ISO9001
CE Mark
CC006A
Standards Of
Excellence

All Cast Iron Frame
Ribbed Design For
Maximum Cooling

Class F
Winding
Insulation

All Ratings
Totally Enclosed
Fan Cooled

All Steel
Fan Cover
(Cast Iron Available)

NEMA Design D
Rated
5% - 8%
High Slip

All Cast Iron
Junction Box
With Rubber Gasket
And Rubber Dust Curtain

Solid
All Cast Iron
Mounting Feet

SKF Brand
Premium Quality
Ball Bearings

V-Ring
Shaft Seals On
Drive-End and
Opposite Drive-End

Standard NEMA
"T" Frame
F-2 Mount
Configuration
For Oil Well Pump

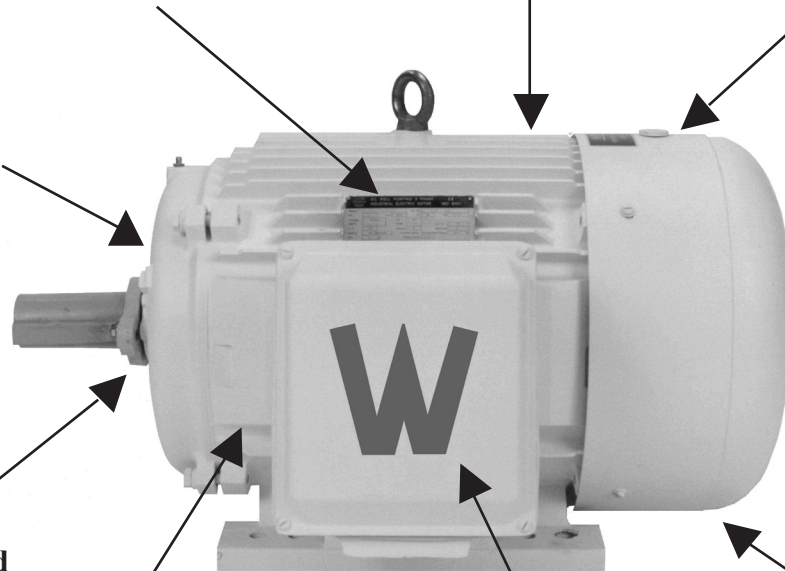

ISO9001



CC006A

Oil Well Pump Three-Phase Motors

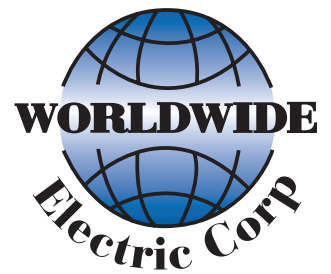

Performance Data

HP	RPM	Voltage	Frame Size	FL Amps 230 V	FL Amps 460 V	FL Torque (Lb. Ft.)	LRT (%)	BDT (%)	FL Eff. (%)	FL P.F.	S.F.
3	1200	208-230/460	213T	8.8	4.4	14.1	300%	270%	79.0%	0.75	1.15
5	1200	208-230/460	215T	14.6	7.3	23.5	300%	270%	82.0%	0.76	1.15
7.5	1200	208-230/460	254T	20.0	10.0	34.6	280%	340%	86.5%	0.79	1.15
10	1200	208-230/460	256T	28.0	14.0	46.2	330%	330%	87.0%	0.79	1.15
15	1200	208-230/460	284T	38.0	19.0	69.4	275%	300%	87.0%	0.85	1.15
20	1200	208-230/460	286T	51.0	25.5	92.7	275%	280%	87.5%	0.85	1.15
25	1200	208-230/460	324T	63.0	31.5	115.6	310%	300%	89.0%	0.87	1.15
30	1200	208-230/460	326T	76.0	38.0	138.4	350%	320%	88.5%	0.85	1.15
40	1200	208-230/460	365T	99.0	49.5	185	290%	300%	89.0%	0.83	1.15
50	1200	208-230/460	404T	116	58.0	232.3	330%	300%	89.0%	0.91	1.15
60	1200	208-230/460	405T	144	72.0	278.4	325%	310%	90.1%	0.90	1.15
75	1200	208-230/460	444T	180	90.0	348	340%	305%	91.4%	0.91	1.15
100	1200	208-230/460	445T	240	120	462.1	328%	312%	92.0%	0.92	1.15

Oil Well Pump Three-Phase Motors



Performance Data

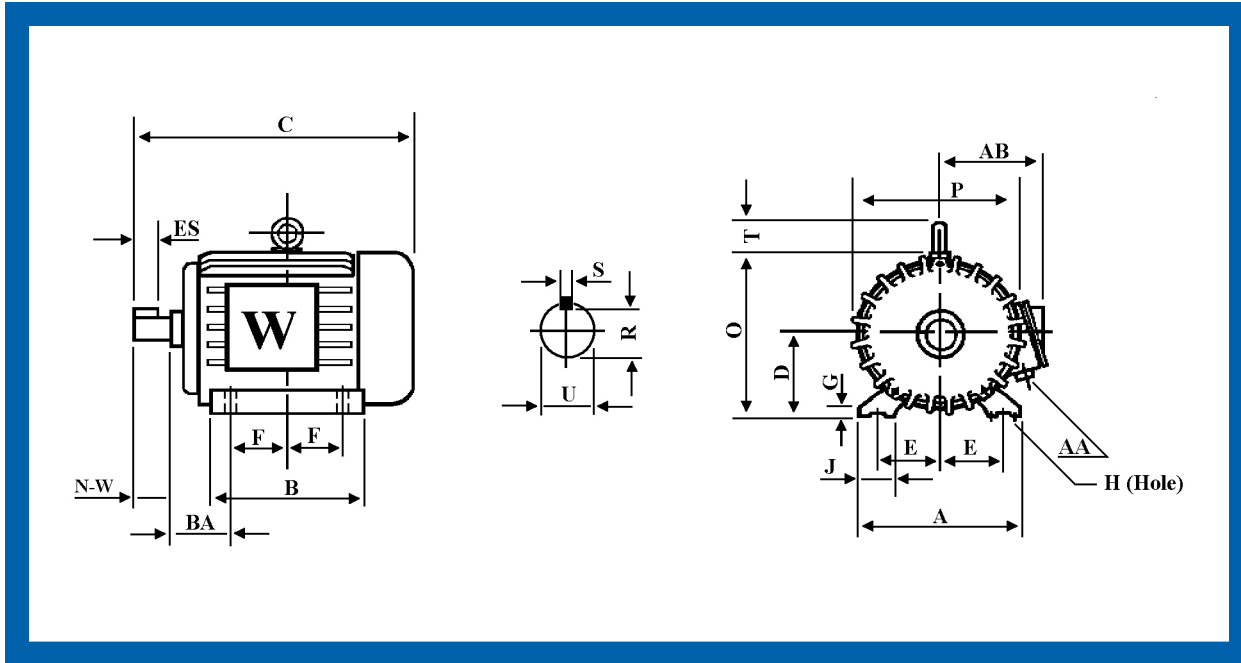

FRAME SIZE	A	B	C	D	E	F	G	H	J	N-W	O	P	R	S	T	U	ES	AA	AB	BA
213T	10.5	7.5	18.89	5.25	4.25	2.75	0.709	0.41	2.36	3.375	10.53	10.4	1.201	0.312	1.73	1.375	2.41	1"	8.63	3.5
215T	10.5	9	20.49	5.25	4.25	3.5	0.709	0.41	2.36	3.375	10.53	10.4	1.201	0.312	1.73	1.375	2.41	1"	8.63	3.5
254T	12.5	10.8	23.29	6.25	5	4.125	0.787	0.53	2.76	4	12.89	12.6	1.416	0.375	2.05	1.625	2.91	1.5"	11.2	4.25
256T	12.5	12.5	25.06	6.25	5	5	0.787	0.53	2.76	4	12.89	12.6	1.416	0.375	2.05	1.625	2.91	1.5"	11.2	4.25
284T	14	12.5	26.64	7	5.5	4.75	0.866	0.53	2.76	4.625	14.28	14.17	1.591	0.5	2.05	1.875	3.28	1.5"	12	4.75
286T	14	14	28.18	7	5.5	5.5	0.866	0.53	2.76	4.625	14.28	14.17	1.591	0.5	2.05	1.875	3.28	1.5"	12	4.75
324T	16	14	29.95	8	6.25	5.25	0.984	0.66	2.76	5.25	15.91	15.75	1.845	0.5	2.44	2.125	3.91	2"	13.4	5.25
326T	16	15.5	31.24	8	6.25	6	0.984	0.66	2.76	5.25	15.91	15.75	1.845	0.5	2.44	2.125	3.91	2"	13.4	5.25
365T	18	16.2	34.11	9	7	6.125	1.102	0.66	2.95	5.875	18.13	17.7	2.021	0.625	2.44	2.375	4.28	3"	15.7	5.88
404T	20	16.2	36.81	10	8	6.125	1.18	0.81	3.15	7.25	21.02	21.42	2.45	0.75	2.83	2.875	5.65	3"	18.31	6.62
405T	20	17.8	38.35	10	8	6.875	1.18	0.81	3.15	7.25	21.02	21.42	2.45	0.75	2.83	2.875	5.65	3"	18.31	6.62
444T	22	18.5	42.52	11	9	7.25	1.38	0.81	3.35	8.5	22.97	23.43	2.88	0.875	3.46	3.375	6.91	2 x 3"	19.41	7.5
445T	22	20.5	44.5	11	9	8.25	1.38	0.81	3.35	8.5	22.97	23.43	2.88	0.875	3.46	3.375	6.91	2 x 3"	19.41	7.5

A Complete Family Of Motor Products



**56-Frame
Motors**

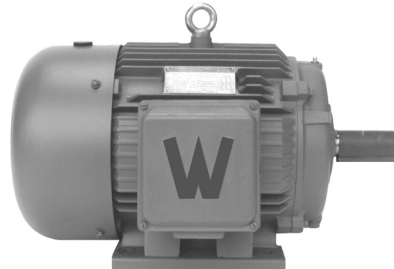

**T-Frame
Motors**

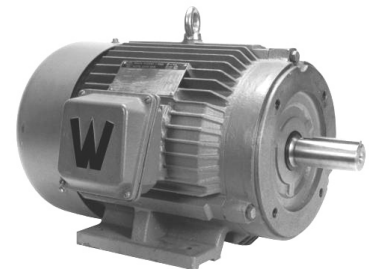

**TC-Frame
Motors**



**Explosion Proof
Motors**



**Vertical Hollow
Shaft Motors**

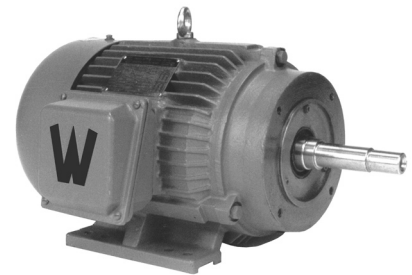

**Close Coupled
Pump Motors**

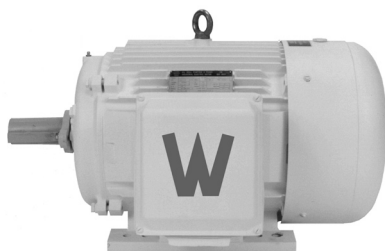

**Oil Well
Pump Motors**



**Rock Crusher
Motors**



**Single-Phase
T-Frame Motors**

***“The Leader In Providing High Quality,
Low Cost, Sourced Motors”***